

C-PVC Pipe & Fittings

C-PVC Pipe	P.066
C-PVC Fittings	P.067
Expansion Joint/Prefab Joint	P.075
Flange	P.077
Welding Rod	P.077
Technical Document	P.078



Heat-Resistant

PRODUCT MODEL CODE LIST

Type	Field	Material	Standard/Wall Thickness	Standard	Type	Size	Length
P	N	S	PP	J	N	***	**
⋮	⋮	⋮	⋮	⋮	⋮	⋮	⋮
P Pipe	N Standard	S Super	PP Straight Pipe VP	J JIS	N Standard	013 13mm I 200 200mm	04 4m 05 5m

Straight Pipe (C-PVC Pipe)

PRODUCT MODEL CODE

P N S PP J N Size

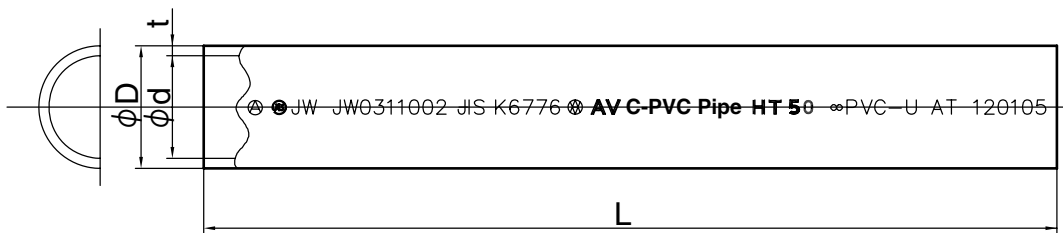

Dimensions Table

(Unit: mm)

Category	Outer Diameter	D		t		L		Approximate Inner Diameter (Reference)	Mass (kg/m) (Reference)
		Tolerance		Thickness		Length			
		Max/Min.	Average	Basic Dimension	Tolerance	Basic Dimension	Tolerance		
○ 13	18.0	±0.20	±0.20	2.5	±0.2	4000	+30 -10	13	0.180
○ 16	22.0	±0.20	±0.20	3.0	±0.3			16	0.265
○ 20	26.0	±0.20	±0.20	3.0	±0.3			20	0.321
○ 25	32.0	±0.20	±0.20	3.5	±0.3			25	0.464
○ 30	38.0	±0.30	±0.20	3.5	±0.3			31	0.561
○ 40	48.0	±0.30	±0.20	4.0	±0.3			40	0.818
○ 50	60.0	±0.40	±0.20	4.5	±0.4	4000 5000*	±10	51	1.161
□ 65	76.0	±0.50	±0.30	4.5	±0.4			67	1.496
□ 75	89.0	±0.50	±0.30	5.9	±0.4			77	2.279
□ 100	114.0	±0.60	±0.40	7.1	±0.5			100	3.528
□ 125	140.0	±0.80	±0.50	7.5	±0.5			125	4.620
□ 150	165.0	±1.00	±0.50	9.6	±0.7			146	6.935
□ 200*	216.0	±1.30	±0.70	11.0	±0.7	194	10.483		

- Notes: 1. ○ are JIS K6776 (Heat-Resistant Unplasticized Polyvinyl Chloride Pipe).
 2. □ conform to the AV standard. Dimensions are accordance with JIS K6741 (Unplasticized Polyvinyl Chloride Pipe).
 3. Size 200 and length 5 m are build-to-order products.

PRODUCT MODEL CODE LIST

Type	Field	Material	Model	Standard	Type	Size
T	N	S	**	J	N	***
⋮	⋮	⋮	⋮	⋮	⋮	⋮
T TS Fitting	N Standard	S Super	9L Elbow 4L 45° Elbow 45 45° Bend SO Socket TE Tee KS Faucet Socket (Metal contained) KL Faucet Elbow (Metal contained) KV Valve Socket (Metal contained)	J JIS	N Standard	013 13mm 150 150mm 013 13mm 016013 16×13mm 150125 150×125mm

Type	Field	Material	Model	Standard	Others	Size
B	N	S	45	V	N	***
⋮	⋮	⋮	⋮	⋮	⋮	⋮
B Bend	N None Color	S Super	45 45° Bend	V AV	N Normal Color	040 40mm 150 150mm

Type	Field	Material	Model	Standard	Others	Size
T	N	S	**	V	N	200
⋮	⋮	⋮	⋮	⋮	⋮	⋮
T TS Fitting	N Standard	S Super	9L 90° Elbow SO Socket	V AV	N Normal Color	200 200mm

C-PVC Fittings Connection Part Dimensions

A-Style (Injection Molding Product)

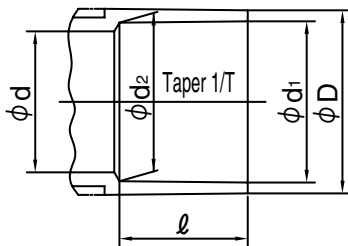

■ Dimensions Table

(Unit: mm)

Size	d ₁		l		d ₂		d (Min.)	D (Min.)	Taper 1/T
	Basic Dimension	Tolerance	Basic Dimension	Tolerance	Basic Dimension	Tolerance			
○ 13	18.30	±0.20	22	±4	17.55	±0.25	14	26	—
○ 16	22.35	±0.20	27	±4	21.55	±0.25	17	29	—
○ 20	26.35	±0.20	33	±4	25.50	±0.25	21	34	—
○ 25	32.50	±0.30	38	±4	31.40	±0.35	26	41	—
○ 30	38.50	±0.30	42	±4	37.45	±0.35	34	46	—
○ 40	48.50	±0.30	47	±4	47.45	±0.35	40	56	—
○ 50	60.50	±0.30	52	±4	59.45	±0.35	50	69	—
□ 65	76.60	±0.30	61	⁺⁴ _{-0.5}	—	—	67	87	1/48
□ 75	89.60	±0.30	64	⁺⁴ _{-0.5}	—	—	77	102	1/49
□ 100	114.70	±0.30	84	⁺⁴ _{-0.5}	—	—	100	130	1/56
□ 125	140.80	±0.30	104	⁺⁴ _{-0.5}	—	—	125	157	1/58
□ 150	166.00	±0.40	132	⁺⁴ _{-0.5}	—	—	146	186	1/63

Notes: 1. ○ are JIS K6777 (Heat-Resistant Unplasticized Polyvinyl Chloride Pipe Fitting). 2. □ conform to the AV standard. 3. Size 75, 100 and 150 are accordance with JIS K6743 (Tap Water Unplasticized Polyvinyl Chloride Pipe Fitting). 4. Size 65 and 125 are accordance with the association standard (AS 21).

C-PVC Fittings Connection Part Dimensions

Combination Type

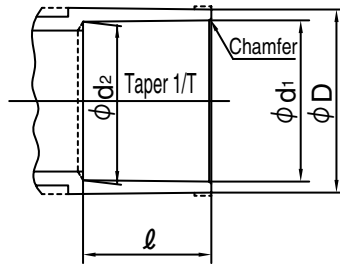

Dimensions Table

(Unit: mm)

Size	d ₁		l		d ₂ (Reference)	D		Taper 1/T
	Basic Dimension	Tolerance	Basic Dimension	Tolerance		Basic Dimension	Tolerance	
□ 13	18.40	±0.20	26	⁺⁴ / _{-0.5}	17.53	24	-0.60	1/30
□ 16	22.40	±0.20	30	⁺⁴ / _{-0.5}	21.52	29	-0.80	1/34
□ 20	26.45	±0.20	35	⁺⁴ / _{-0.5}	25.42	33	-0.80	1/34
□ 25	32.55	±0.25	40	⁺⁴ / _{-0.5}	31.37	40	-1.00	1/34
□ 30	38.60	±0.25	44	⁺⁴ / _{-0.5}	37.31	46	-1.00	1/34
□ 40	48.70	±0.30	55	⁺⁴ / _{-0.5}	47.21	57	-1.20	1/37
□ 50	60.80	±0.30	63	⁺⁴ / _{-0.5}	59.10	70	-1.50	1/37
□ 65	76.60	±0.30	61	⁺⁴ / _{-0.5}	75.33	87	-1.50	1/48
□ 75	89.60	±0.30	64	⁺⁴ / _{-0.5}	88.29	102	-1.50	1/49
□ 100	114.70	±0.30	84	⁺⁴ / _{-0.5}	113.20	130	-1.80	1/56
□ 125	140.80	±0.30	104	⁺⁴ / _{-0.5}	139.01	157	-1.80	1/58
□ 150	166.00	±0.40	132	⁺⁴ / _{-0.5}	163.91	186	-2.00	1/63

Notes: 1. □ conform to the AV standard. 2. Size 13, 20, 25, 30, 40, 50, 75, 100 and 150 are accordance with JIS K6743 (Tap Water Unplasticized Polyvinyl Chloride Pipe Fitting). 3. Size 16, 65 and 125 are accordance with the association standard (AS 21).

Elbow

Abbreviation: **L**

PRODUCT MODEL CODE

TS ▶ T N S 9L J N Size

Elbow (A-Style)

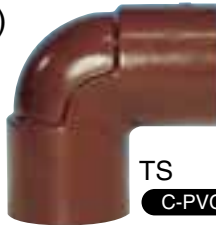

TS
C-PVC / HT

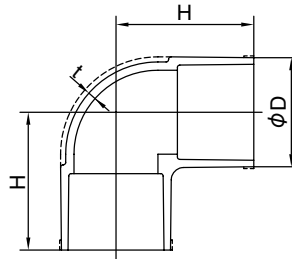

Dimensions Table

(Unit: mm)

Size	D (Min.)		t (Min.)	H		Size	D (Min.)		t (Min.)	H	
	Basic Dimension	Tolerance		Basic Dimension	Tolerance		Basic Dimension	Tolerance		Basic Dimension	Tolerance
○ 13	26	—	3.5	34	±4	○ 50	69	—	5.0	85	±4
○ 16	29	—	3.5	41	±4	□ 65	87	-1.5	6.6	110	⁺⁵ / ₋₁
○ 20	34	—	4.0	53	±4	□ 75	102	-1.5	8.0	120	⁺⁵ / ₋₁
○ 25	41	—	4.0	58	±4	□ 100	130	-1.8	10.0	155	⁺⁵ / ₋₁
○ 30	46	—	4.5	64	±4	□ 125	157	-1.8	11.0	188	⁺⁵ / ₋₁
○ 40	56	—	4.5	74	±4	□ 150	186	-2.0	13.0	228	⁺⁵ / ₋₁

Notes: 1. ○ are JIS K6777 (Heat-Resistant Unplasticized Polyvinyl Chloride Pipe Fitting). 2. □ conform to the AV standard. 3. Connection part dimensions are A-Style.

Short Elbow

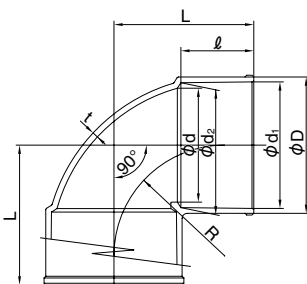

Dimensions Table

(Unit: mm)

Size	d ₁		d ₂		l		D	d	t		L	R
	Basic Dimension	Tolerance	Basic Dimension	Tolerance	Basic Dimension	Tolerance			Basic Dimension	Tolerance		
200	217	±1.0	214.5	±1.0	145	⁺⁴ / _{-0.5}	236	196	15	±0.8	265	190

Notes: 1. It conforms to the AV standard.

45° Elbow/Bend

Abbreviation: **45L**

PRODUCT MODEL CODE

20, 25	T	N	S	4L	J	N	Size
40 to 150	B	N	S	45	V	N	Size

45° Elbow



TS
C-PVC / HT

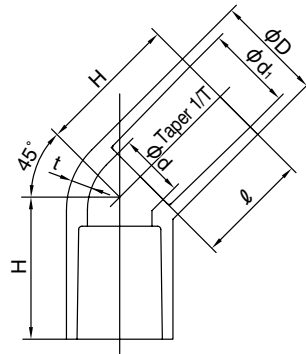

Dimensions Table

(Unit: mm)

Size	d ₁		Taper 1/T	ℓ		d	D		t		H	
	Basic Dimension	Tolerance		Basic Dimension	Tolerance		Basic Dimension	Tolerance	Basic Dimension	Tolerance	Basic Dimension	Tolerance
□ 20	26.45	±0.25	1/34	35.0	⁺⁴ _{-0.5}	20	33.0	-0.8	3.5	-0.3	44	⁺⁵ ₋₁
□ 25	32.55	±0.20	1/34	40.0	⁺⁴ _{-0.5}	25	40.0	-1.0	4.0	-0.4	51	⁺⁵ ₋₁

Notes: 1. □ conform to the AV standard.

45° Bend

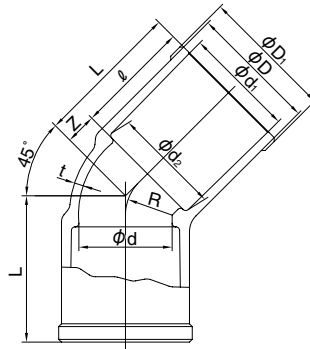

Dimensions Table

(Unit: mm)

Size	d ₁		d ₂		ℓ		D	D ₁	d (Min.)	t		Z	L	R
	Basic Dimension	Tolerance	Basic Dimension	Tolerance	Basic Dimension	Tolerance				Basic Dimension	Tolerance			
□ 40	48.70	±0.30	47.21	±0.30	55	⁺⁴ _{-0.5}	57	60	40	4.5	^{+0.45} ₋₀	14	69	20.0
□ 50	60.80	±0.30	59.10	±0.30	63	⁺⁴ _{-0.5}	70	73	51	5.0	^{+0.5} ₋₀	17	80	25.5
□ 65	76.60	±0.30	75.33	±0.30	61	⁺⁴ _{-0.5}	87	90	67	6.6	^{+0.5} ₋₀	20	81	34.0
□ 75	89.80	±0.30	88.13	±0.30	72	⁺⁴ _{-0.5}	101	104	78	6.0	^{+0.8} ₋₀	25	97	39.0
□ 100	115.00	±0.35	112.89	±0.35	92	⁺⁴ _{-0.5}	129	132	100	7.3	^{+1.0} ₋₀	30	122	50.0
□ 125	141.20	±0.40	138.71	±0.40	112	⁺⁴ _{-0.5}	156	160	125	7.7	^{+1.0} ₋₀	37	149	62.5
□ 150	166.50	±0.50	163.39	±0.50	140	⁺⁴ _{-0.5}	185	189	148	10.0	^{+1.0} ₋₀	44	184	74.0

Notes: 1. □ conform to the AV standard.

Cap

Abbreviation: **C**

PRODUCT MODEL CODE

TS	T	N	S	CP	J	N	Size
----	---	---	---	----	---	---	------

Cap



TS
C-PVC / HT

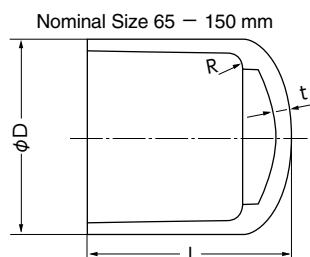

Dimensions Table

(Unit: mm)

Size	D	t	L
□ 65	87 -1.5	8.6	96
□ 75	102 -1.5	8.0	105
□ 100	130 -1.8	10.0	138
□ 150	186 -2.0	13.0	205

Notes: 1. L tolerance should be +5mm,0.
2. □ conform to the AV standard.
3. R tolerance should be 1 to 5mm.

Socket

Abbreviation: **S**

PRODUCT MODEL CODE

TS ▶ T N S SO J N Size

Socket (A-Style)



TS
C-PVC / HT

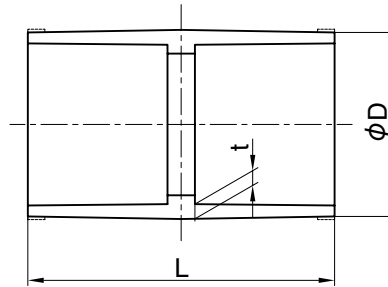

Dimensions Table

(Unit: mm)

Size	D (Min.)		L		t (Min.)
	Basic Dimension	Tolerance	Basic Dimension	Tolerance	
○ 13	26	—	49	±6.0	3.5
○ 16	29	—	59	±6.0	3.5
○ 20	34	—	71	±6.0	4.0
○ 25	41	—	82	±6.0	4.0
○ 30	46	—	89	±6.0	4.5
○ 40	56	—	99	±6.0	4.5
○ 50	69	—	109	±6.0	5.0
□ 65	87	-1.5	145	±6.0	4.6
□ 75	102	-1.5	155	±6.0	5.6
□ 100	130	-1.8	200	±6.0	6.9
□ 125	157	-1.8	231	±6.0	7.3
□ 150	186	-2.0	300	±6.0	9.2

- Notes: 1. ○ are JIS K6777 (Heat-Resistant Unplasticized Polyvinyl Chloride Pipe Fitting).
 2. □ conform to the AV standard.
 3. Connection part dimensions are A-Style.
 4. t dimension for size 65 to 150 is reference value (minimum).

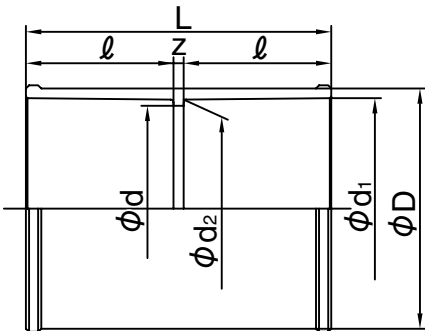

Dimensions Table

(Unit: mm)

Size	d ₁		d ₂		ℓ	D	d	Z	L
	Basic Dimension	Tolerance	Basic Dimension	Tolerance	Basic Dimension				
□200	217	±1.0	214.5	±1.0	145	238	202	15	305

- Notes: 1. □ conform to the AV standard.

Reducing Socket

Abbreviation: **S**

PRODUCT MODEL CODE

TS ▶ T N S SO J N Size

Reducing Socket (A-Style)



TS
C-PVC / HT

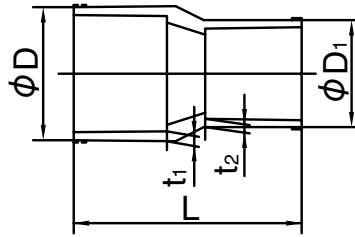

Dimensions Table

(Unit: mm)

Size	D (Min.)		D ₁ (Min.)		L		t ₁ (Min.)	t ₂ (Min.)
	Basic Dimension	Tolerance	Basic Dimension	Tolerance	Basic Dimension	Tolerance		
○ 16×13	29	—	26	—	53.0	±5	3.5	3.5
○ 20×13	34	—	26	—	61.5	±5	4.0	3.5
○ 20×16	34	—	29	—	66.0	±5	4.0	3.5
○ 25×13	41	—	26	—	73.0	±5	4.0	3.5
○ 25×16	41	—	29	—	76.0	±5	4.0	3.5
○ 25×20	41	—	34	—	80.5	±5	4.0	4.0
○ 30×13	46	—	26	—	75.0	±5	4.5	3.5
○ 30×20	46	—	34	—	85.0	±5	4.5	4.0
○ 30×25	46	—	41	—	90.0	±5	4.5	4.0
○ 40×20	56	—	34	—	98.0	±5	4.5	4.0
○ 40×25	56	—	41	—	100.0	±5	4.5	4.0
○ 40×30	56	—	46	—	97.0	±5	4.5	4.5
○ 50×25	69	—	41	—	110.0	±5	5.0	4.0
○ 50×30	69	—	46	—	110.0	±5	5.0	4.5
○ 50×40	69	—	56	—	110.0	±5	5.0	4.5
□ 65×50	87	-1.5	70	-1.5	149.0	±4	5.0	5.0
□ 75×50	102	-1.5	70	-1.5	165.0	±4	8.0	5.0
□ 75×65	102	-1.5	87	-1.5	163.0	±4	8.0	5.0
□ 100×75	130	-1.8	102	-1.5	190.0	±4	10.0	8.0

- Notes: 1. ○ are JIS K6777 (Heat-Resistant Unplasticized Polyvinyl Chloride Pipe Fitting).
 2. □ conform to the AV standard.
 3. Connection part dimensions are A-Style.

Reducing Socket (Combination type)



TS
C-PVC / HT

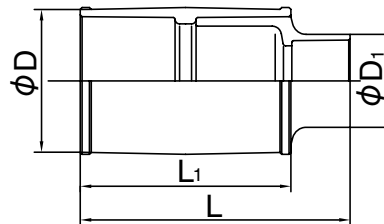

Dimensions Table

(Unit: mm)

Size	D	D ₁	D ₂	L	L ₁
□ 65× 30	87	46	70	194	149
□ 65× 40	87	57	70	205	149
□ 75× 40	102	57	70	221	165
□ 100× 40	130	57	102	246	190
□ 100× 50	130	70	102	252	190
□ 100× 65	130	87	102	250	190
□ 125× 75	157	102	—	296	231
□ 125×100	157	130	—	316	231
□ 150× 75	186	102	—	365	300
□ 150×100	186	130	—	385	300
□ 150×125	186	157	—	404	300

- Notes: 1. □ conform to the AV standard.
 2. Connection part dimensions are the combination type.

Tee

Abbreviation: **T**

PRODUCT MODEL CODE

TS ▶ T N S TE J N Size

Tee (A-Style)



TS
C-PVC / HT

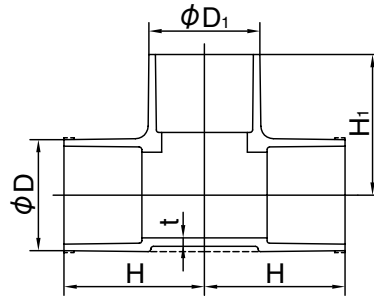

Dimensions Table

(Unit: mm)

Size	D (Min.)		t (Min.)	H		D1 (Min.)		H1	
	Basic Dimension	Tolerance		Basic Dimension	Tolerance	Basic Dimension	Tolerance	Basic Dimension	Tolerance
○ 13× 13	26	3.5	3.5	34	±4	26	—	34	±4
○ 16× 16	29	3.5	3.5	41	±4	29	—	41	±4
○ 20× 20	34	4.0	4.0	53	±4	34	—	53	±4
○ 25× 25	41	4.0	4.0	58	±4	41	—	58	±4
○ 30× 30	46	4.5	4.5	64	±4	46	—	64	±4
○ 40× 40	56	4.5	4.5	75	±4	56	—	75	±4
○ 50× 50	69	5.0	5.0	87	±4	69	—	87	±4
□ 65× 65	87 -1.5	6.6	6.6	110 ⁺⁵ ₋₁	—	87 -1.5	—	110 ⁺⁵ ₋₁	—
□ 75× 75	102 -1.5	8.0	8.0	120 ⁺⁵ ₋₁	—	102 -1.5	—	120 ⁺⁵ ₋₁	—
□ 100×100	130 -1.8	10.0	10.0	152 ⁺⁵ ₋₁	—	130 -1.8	—	152 ⁺⁵ ₋₁	—
□ 125×125	157 -1.8	11.0	11.0	187 ⁺⁵ ₋₁	—	157 -1.8	—	187 ⁺⁵ ₋₁	—
□ 150×150	186 -2.0	13.0	13.0	230 ⁺⁵ ₋₁	—	186 -2.0	—	230 ⁺⁵ ₋₁	—

Notes: 1. ○ are JIS K6777 (Heat-Resistant Unplasticized Polyvinyl Chloride Pipe Fitting). 2. □ conform to the AV standard. 3. Connection part dimensions are A-Style.

Reducing Tee (A-Style)



TS
C-PVC / HT

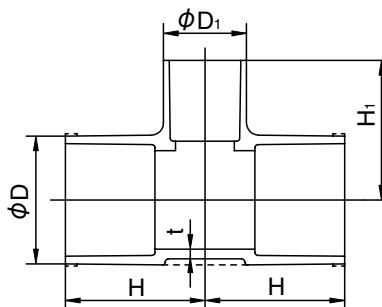

Dimensions Table

(Unit: mm)

Size	D (Min.)		t (Min.)	D1 (Min.)		H	H1	H and H1 Tolerance	Size	D (Min.)		t (Min.)	D1 (Min.)		H	H1	H and H1 Tolerance
	Basic Dimension	Tolerance		Basic Dimension	Tolerance					Basic Dimension	Tolerance		Basic Dimension	Tolerance			
○ 16× 13	29	3.5	3.5	26	39	36	±4	○ 50× 20	69	—	5.0	34	—	72	70	±4	
○ 20× 13	34	4.0	4.0	26	45	38	±4	○ 50× 25	69	—	5.0	41	—	75	75	±4	
○ 20× 16	34	4.0	4.0	29	47	43	±4	○ 50× 30	69	—	5.0	46	—	79	75	±4	
○ 25× 13	41	4.0	4.0	26	49	41	±4	○ 50× 40	69	—	5.0	56	—	82	80	±4	
○ 25× 16	41	4.0	4.0	29	52	46	±4	□ 65× 40	87	-1.5	6.6	57	-1.2	95	95	⁺⁵ ₋₁	
○ 25× 20	41	4.0	4.0	34	54	52	±4	□ 65× 50	87	-1.5	6.6	70	-1.5	102	104	⁺⁵ ₋₁	
○ 30× 13	46	4.5	4.5	26	54	44	±4	□ 75× 25	102	-1.5	8.0	40	-1.0	93	88	⁺⁵ ₋₁	
○ 30× 16	46	4.5	4.5	29	56	49	±4	□ 75× 40	102	-1.5	8.0	57	-1.2	100	102	⁺⁵ ₋₁	
○ 30× 20	46	4.5	4.5	34	58	55	±4	□ 75× 50	102	-1.5	8.0	70	-1.5	105	110	⁺⁵ ₋₁	
○ 30× 25	46	4.5	4.5	41	60	60	±4	□ 100× 50	130	-1.8	10.0	70	-1.5	125	122	⁺⁵ ₋₁	
○ 40× 13	56	4.5	4.5	26	62	49	±4	□ 100× 75	130	-1.8	10.0	102	-1.5	140	132	⁺⁵ ₋₁	
○ 40× 16	56	4.5	4.5	29	63	54	±4	□ 125× 75	157	-1.8	12.0	102	-1.5	161	147	⁺⁵ ₋₁	
○ 40× 20	56	4.5	4.5	34	65	60	±4	□ 125×100	157	-1.8	12.0	130	-1.8	175	167	⁺⁵ ₋₁	
○ 40× 25	56	4.5	4.5	41	68	65	±4	□ 150× 75	186	-2.0	13.0	102	-1.5	195	158	⁺⁵ ₋₁	
○ 40× 30	56	4.5	4.5	46	72	69	±4	□ 150×100	186	-2.0	13.0	130	-1.8	208	182	⁺⁵ ₋₁	
○ 50× 13	69	5.0	5.0	26	69	55	±4	□ 150×125	186	-2.0	13.0	157	-1.8	218	202	⁺⁵ ₋₁	
○ 50× 16	69	5.0	5.0	29	70	60	±4										

Notes: 1. ○ are JIS K6777 (Heat-Resistant Unplasticized Polyvinyl Chloride Pipe Fitting). 2. □ conform to the AV standard. 3. Connection part dimensions are A-Style.

Tee

Abbreviation: **T**

PRODUCT
MODEL CODE

TS ▶ T N S TE J N Size

Reducing Tee (Combination Type)



TS
C-PVC / HT

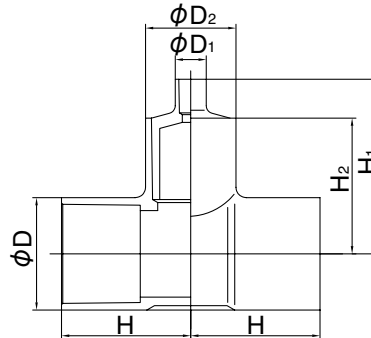

Dimensions Table

(Unit: mm)

Size	D	D ₁	D ₂	H	H ₁	H ₂
□ 65×13	87	24	70	100	135	105
□ 65×16	87	29	70	100	137	105
□ 65×20	87	33	70	100	142	105
□ 65×25	87	40	70	100	147	105
□ 65×30	87	46	70	100	150	105
□ 75×20	102	33	70	105	147	110
□ 75×30	102	46	70	105	155	110
□ 100×20	134	33	70	125	159	122
□ 100×25	134	40	70	125	164	122
□ 100×30	134	46	70	125	167	122
□ 100×40	134	57	70	125	178	122

Notes: 1. □ conform to the AV standard. 2. Connection part dimensions are the combination type.

Faucet Socket (A-Style) (Metal Insert Included)

Abbreviation: **KFS**

PRODUCT
MODEL CODE

TS ▶ T N S KS J N Size



TS
C-PVC / HT

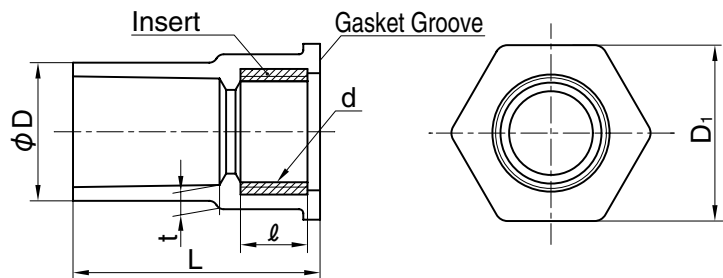

Dimensions Table

(Unit: mm)

Size	D (Min.)	Threaded End		ℓ		D ₁	L		t (Min.)
		Root Diameter D ₁	Number of Threads (per 25.4 mm)	Basic Dimension	Tolerance		Basic Dimension	Tolerance	
○13	26	20.955	14	13.5	±1	35	47	±4	3.5
○16×13	29	20.955	14	13.5	±1	35	52	±4	3.5
○20	34	26.441	14	15.5	±1	44	61	±4	4.0
○25	41	33.249	11	18	±1	54	69	±4	4.0
□20×13	33	20.955	14	14	±1	35	57	±4	4.0

Notes: 1. ○ are JIS K6777 (Heat-Resistant Unplasticized Polyvinyl Chloride Pipe Fitting).

2. □ conform to the AV standard.

3. Connection part dimensions are A-Style.

4. Insert material of threaded end is CAC406 of JIS H5120 and CAC406406C of JIS H5121 or free-cutting brass of JIS H3250.

5. Threaded end is parallel female thread of JIS B0203.

<Use Precautions>

* Use both seal tape and gasket for connection of threaded ends. Do not use liquid seal or liquid gasket.

Faucet Elbow (A-Style) (Metal Insert Included)

Abbreviation: **KFL**

PRODUCT
MODEL CODE

TS ▶ T N S KL J N Size



TS
C-PVC / HT

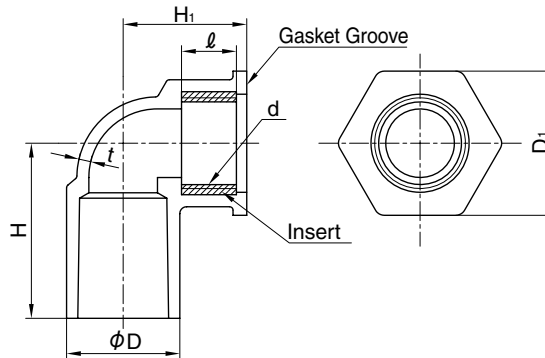

Dimensions Table

(Unit: mm)

Size	D (Min.)	t (Min.)	H	Threaded End		l		D1	H1	
				Root Diameter: D1	Number of Threads (per 25.4 mm)	Basic Dimension	Tolerance		Basic Dimension	Tolerance
○13	26	3.5	35	20.955	14	13.5	±1	35	29	±4
○16×13	29	4.8	42	20.955	14	13.5	±1	35	33	±4
○20	34	4.0	51	26.441	14	15.5	±1	44	36	±4
○25	41	4.0	60	33.249	11	18	±1	54	40	±4
□20×13	36	4.8	47	20.955	14	14	±1	35	35	±4

- Notes: 1. ○ are JIS K6777 (Heat-Resistant Unplasticized Polyvinyl Chloride Pipe Fitting).
 2. □ conform to the AV standard.
 3. Connection part dimensions are A-Style.
 4. Insert material of threaded end is CAC406 of JIS H5120 and CAC406406C of JIS H5121 or free-cutting brass of JIS H3250.
 5. Threaded end is parallel female thread of JIS B0203.

<Use Precautions>

* Use both seal tape and gasket for connection of threaded ends. Do not use liquid seal or liquid gasket.

Valve Socket with Metal Male Thread (A-Style)

Abbreviation: **KVS**

PRODUCT
MODEL CODE

TS ▶ T N S KV J N Size



TS
C-PVC / HT

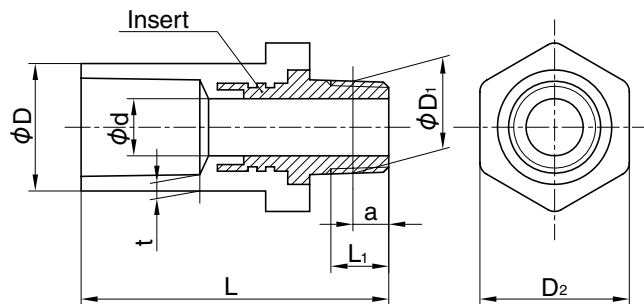

Dimensions Table

(Unit: mm)

Size	D (Min.)	d	Threaded End				L		D2	t (Min.)	
			Standard Outer Shape: D1	Number of Threads (per 25.4 mm)	Standard Position a	a Tolerance	Effective threaded Length L1 (Min.)	Basic Dimension			Tolerance
○13× 1/2	26	13	20.955	14	8.16	±1.81	13.16	64	±4	34	3.5
○16× 1/2	29	13	20.955	14	8.16	±1.81	13.16	70	±4	34	3.5
○20× 3/4	34	18	26.441	14	9.53	±1.81	14.53	85	±4	40	4.0
○25×1	41	23	33.249	11	10.39	±2.31	16.79	99	±4	45	4.0
○30×11/4	46	31	41.910	11	12.70	±2.31	19.10	109	±4	62	4.5
○40×11/2	56	37	47.803	11	12.70	±2.31	19.10	114	±4	68	4.5
○50×2	69	48	59.614	11	15.88	±2.31	23.38	132	±4	84	5.0

- Notes: 1. ○ are JIS K6777 (Heat-Resistant Unplasticized Polyvinyl Chloride Pipe Fitting).
 2. Connection part dimensions are A-Style.
 3. Insert material of threaded end is CAC406 of JIS H5120 and CAC406406C of JIS H5121 or free-cutting brass of JIS H3250.
 4. Threaded end is tapered male thread of JIS B0203.

<Use Precautions>

* Use both seal tape and gasket for connection of threaded ends. Do not use liquid seal or liquid gasket.

PRODUCT MODEL CODE LIST

Model	Material	Rubber	Connection	Standard	Size
JEP	S	*	T	J	***
⋮	⋮	⋮	⋮	⋮	⋮
JEP Expansion Joint	S Super	E EPDM V FKM F Viflon®/FKM-F C Viflon®C/FKM-C	T Socket	J JIS	020 20mm 100 100mm

Expansion Joint



Features

- Expansion/contraction absorption margin is large and the thermal stress of piping is absorbed.
- Easy removal from piping by just loosening the union nut.
- No need for a large piping space with the compact design.
- No need for installation of piping expansion U bend.
- No slipping of pipe. (Because stop ring ⑤ is provided)

Dimensions Table

(Unit: mm)

Size		d	d ₁	ℓ ₁	1/T	D ₂	D ₁	D ₃	L		ℓ ₂
mm	inch								Max.	Min.	Expansion/Contraction Margin
20	3/4	20	26.13	24	1/34	35	60	35	243	163	80
25	1	25	32.16	27	1/34	43	70	39	250	170	80
30	1 1/4	31	38.19	30	1/34	50	82	47	258	178	80
40	1 1/2	40	48.21	37	1/37	59	100	59	272	192	80
50	2	51	60.25	42	1/37	72	106	72	285	205	80
65	2 1/2	65	76.60	61	1/48	88	133	88	314	234	80
75	3	78	89.60	64	1/49	105	152	105	330	250	80
100	4	100	114.70	84	1/56	132	210	132	422	322	100

Parts Table

No.	Description	Pcs.	Material
①	Body	1	C-PVC
②	End Connector (A)	1	C-PVC
③	End Connector (B)	1	C-PVC
④a	Union Nut (A)	—	C-PVC
④b	Union Nut (B) ¹⁾	1	C-PVC
⑤	Stop Ring	1	C-PVC
⑥	O-Ring (A)	1	EPDM, FKM, Viflon®F (FKM-F), Viflon®C (FKM-C)
⑦	O-Ring (B)	2	EPDM, FKM, Viflon®F (FKM-F), Viflon®C (FKM-C)

1) Use for 65-100mm.

<Use Precautions>

- Make sure to provide the first support (loose support) at 0.5 m or less of an expansion joint on both sides.
- Sufficiently consider the expansion and contraction amounts of piping. (When piping expands: Use the expansion joint being extended to a certain degree.) (When piping contracts: Use the expansion joint being shrunk to a certain degree.)

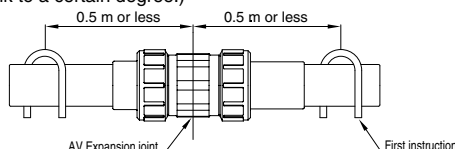

PRODUCT MODEL CODE	Material	Rubber	Connection	Standard	Size	
EPDM	JEP	S	E	T	J	Size
FKM	JEP	S	V	T	J	Size
Viflon®F / FKM-F	JEP	S	F	T	J	Size
Viflon®C / FKM-C	JEP	S	C	T	J	Size

Main Specification

Material	Working Temperature	Maximum Working Pressure (Normal Temperature) MPa(kgf/cm ²)	Connection Socket End
Heat-Resistant Polyvinyl Chloride (C-PVC)	5 — 90°C	1.0{10.2}	○

Dimensions Diagram

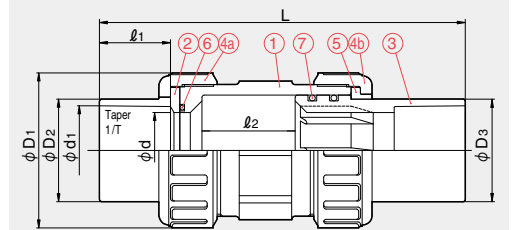

When installing

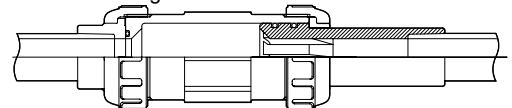

When piping is expanded by heat

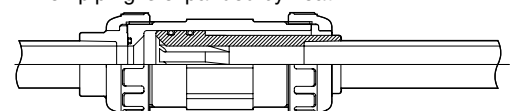

Pipe Heat Expansion Table

(Unit: mm)

Temperature Difference	Piping Length L								
	5m	10m	20m	30m	40m	50m	60m	70m	80m
10°C	4	7	14	21	28	35	42	49	56
20°C	7	14	28	42	56	70	84	98	112
30°C	11	21	42	63	84	105	126	147	168
40°C	14	28	56	84	112	140	168	196	224
50°C	18	35	70	105	140	175	210	245	280
60°C	21	42	84	126	168	210	252	294	336
70°C	25	49	98	147	196	245	294	343	392
80°C	28	56	112	168	224	280	336	392	448

<Example>How often (every XX m) shall expansion joints be inserted when the size is 75 mm and temperature difference is 20°C?

$$\text{Calculation Formula } L = \frac{\Delta \ell}{\alpha \Delta t} \dots \dots \dots (1)$$

L : Length of piping that the expansion joint absorbs (mm)

Δ ℓ : Piping expansion/contraction length

Expansion/contraction margin for 75 mm from the dimensions table ℓ₂=80 mm

Give margins on both ends 5 mm×2=10 mm Δ ℓ :=(80-10) mm

α : Heat expansion coefficient of hard polyvinyl chloride pipe 7×10⁻⁵ (/°C)

Δ t : Temperature difference 20 (°C)

When the value above is assigned to (1)

$$L = \frac{80-10}{7 \times 10^{-5} \times 20} = 50000 \text{ mm}$$

∴ One piece per 50m.

PRODUCT MODEL CODE LIST

Model	Material	Rubber	Connection	Standard	Size
JPF	C	*	T	J	***
⋮	⋮	⋮	⋮	⋮	⋮
JPF Prefab Joint	C C-PVC	E EPDM V FKM F Viflon®F/FKM-F C Viflon®C/FKM-C	T Socket	J JIS	013 13mm I 100 100mm

Prefab Joint

PRODUCT MODEL CODE	EPDM	▶ JPF	C	E	T	J	Size
	FKM	▶ JPF	C	V	T	J	Size
	Viflon®F/FKM-F	▶ JPF	C	F	T	J	Size
	Viflon®C/FKM-C	▶ JPF	C	C	T	J	Size



Features

- Installation is extremely simple and it can be done quickly and certainly. (Especially necessary for sleeve bonding/screw-in piping)
- Installable on piping where suitable and easy cleaning inside pipes.
- After installing piping, the valve parts can be removed by just loosening the union nut. It is suitable for pipelines requiring regular removals such as temporary piping and slurry piping.

Main Specification

Material	Heat-Resistant Polyvinyl Chloride (C-PVC)
Working Temperature	0 – 90°C
Maximum Working Pressure	1.0MPa{10.2kg/cm ² }

Prefab Joint Standard Table

Body Material	Connection Method	13	16	20	25	30	40	50	65	75	100
C-PVC	Socket End	○	○	○	○	○	○	○	○	○	○

Socket End (13 – 50 mm)

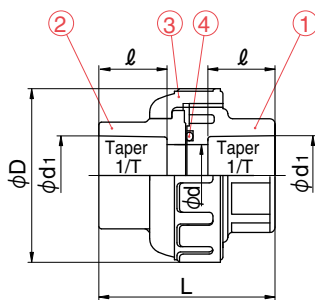

Socket End (65 – 100 mm)

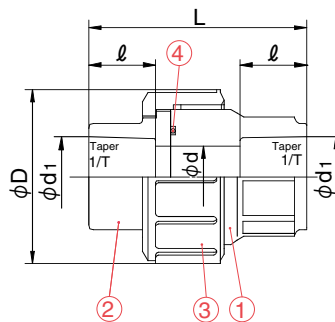

Parts Table

No.	Description	pcs.	Material
①	Body	1	C-PVC
②	End Connector	1	C-PVC
③	Union Nut	1	C-PVC
④	O-Ring	1	EPDM FKM Viflon®F/FKM-F Viflon®C/FKM-C

Dimensions Table

(Unit: mm)

Size	d	Socket end				D
		C-PVC				
		d ₁	ℓ	1/T	L	
13	13	18.13	18	1/30	46	48
16	15	22.11	20	1/34	46	48
20	20	26.13	24	1/34	61	60
25	25	32.16	27	1/34	70	70
30	31	38.19	30	1/34	77	82
40	40	48.21	37	1/37	95	100
50	51	60.25	42	1/37	107	106
65	65	76.60	61	1/48	167	133
75	77	89.60	64	1/49	189.5	152
100	100	114.70	84	1/56	245	210

PRODUCT MODEL CODE LIST

Type	Field	Model	Material	Standard	Size
F	N	T	C	*	***
⋮	⋮	⋮	⋮	⋮	⋮
F Flange	N None Color	T TS Flange	C C-PVC	1 JIS 10K 5 JIS 5K	013 13mm I 200 200mm

TS Flange

PRODUCT MODEL CODE

JIS 10K	▶	F	N	T	C	1	Size
JIS 5K	▶	F	N	T	C	5	Size



C-PVC

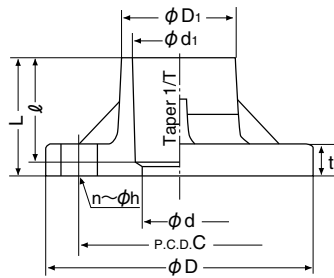

C-PVC JIS 10K 13 – 150 mm, JIS 5K 13 – 65 mm

Dimensions Table

(Unit: mm)

Size	d	d ₁	Taper 1/T	l	D ₁		C		D		pcs.		h		t		L	
					10K	5K	10K	5K	10K	5K	10K	5K	10K	5K	10K	5K	10K	5K
13	15	18.40	1/30	26	28	24	65	55	90	75	4	4	15	12	14	9	30	30
15	18	22.40	1/34	30	33	31	70	60	95	80	4	4	15	12	14	9	35	35
20	22	26.45	1/34	35	36	33	75	65	100	85	4	4	15	12	14	10	40	40
25	25	32.55	1/34	40	43	43	90	75	125	95	4	4	19	12	16	10	50	45
32	30	38.60	1/34	44	51	51	100	90	135	115	4	4	19	15	16	12	50.5	50
40	41	48.70	1/37	55	65	65	105	95	140	120	4	4	19	15	16	12	65	61
50	52	60.80	1/37	63	76	76	120	105	155	130	4	4	19	15	20	14	74	72
65	67	76.80	1/41	69	92	86	140	130	175	155	4	4	19	15	22	14	82	76
80	78	89.80	1/43	72	108	-	150	-	185	-	8	-	19	-	22	-	86	-
100	100	115.00	1/44	92	138	-	175	-	210	-	8	-	19	-	22	-	105	-
125	125	141.20	1/45	112	165	-	210	-	250	-	8	-	23	-	22	-	114	-
150	146	166.00	1/63	132	185	-	240	-	280	-	8	-	23	-	26	-	142	-
* 200	196	217.00	1/50	145	238	-	290	-	330	-	12	-	23	-	28	-	156	-

Notes: 1. Dimensions for C, D, n and h are accordance with the JIS 10K • 5K standards. 2. * Size 200 is build-to-order products.

PRODUCT MODEL CODE LIST

Type	Material			
S	S	*	*	0
⋮	⋮	⋮	⋮	⋮
S Welding Rod	S Super	2 2 mm 3 3 mm	1 Single 2 Double	0

Welding Rod

PRODUCT MODEL CODE

2mm×single	▶	S	S	2	1	0
3mm×single	▶	S	S	3	1	0
3mm×double	▶	S	S	3	2	0



- 2mm x single
- 3mm x single
- 3mm x double

* Color of welding rod is brown, same as C-PVC Pipe.

Technical Data

Property (Basic Property)

	Characteristics	Unit	JIS K6776	Asahi AV C-PVC Pipe
			Heat-Resistant Unplasticized Polyvinyl Chloride Pipe Standard (Applicable area 13 to 50 mm)	(Heat-Resistant Unplasticized Polyvinyl Chloride Pipe)
Physical Property	Specific Gravity	-	Not specified	1.48
	Absorption Amount	mg/cm ²	Not specified	0.03 - 0.05
	Linear Expansion Coefficient	°C ⁻¹	Not specified	6 to 8×10 ⁻⁵
	Specific Heat	cal/g/°C	Not specified	0.2 - 0.3
	Heat Conductivity	kcal/mh °C	Not specified	0.10 - 0.12
	Combustibility	-	Not specified	Self-Extinguishing Ability
	Vicat Softening Temperature	°C	95 or higher	100 - 110
Mechanical Property	Tensile Yield Stress	MPa	50 or more/23°C	50 - 65
	Extension Ratio	%	Not specified	40 or more
	Bending Strength	MPa	Not specified	78
	Compression Strength	MPa	Not specified	78 - 88
	Shear Strength	MPa	Not specified	52 - 55
	Vertical Modulus of Elasticity	MPa	Not specified	3×10 ³
	Poisson's Ratio	-	Not specified	0.38
	Charpy Impact Strength V-Notch	kJ/m ²	Not specified	8 - 10
	Flat Strength	-	Compress a circle test piece of 50 mm to 1/2 of pipe outer diameter and confirm no breaking and cracking.	Pass

Relationship between Maximum Working Pressure and Temperature

JIS K6776 Heat-Resistant Unplasticized Polyvinyl Chloride Pipe Standard (Applicable area 13 to 50 mm) Unit: MPa {kgf/cm²}

Size mm \ Temperature	5 - 40°C	41 - 60°C	61 - 70°C	71 - 90°C
13 - 50	1.0 {10.2}	0.6 {6.1}	0.4 {4.1}	0.2 {2.0}

C-PVC Pipe

Unit: MPa {kgf/cm²}

Size mm \ Temperature	Up to 40°C	Up to 50°C	Up to 60°C	Up to 65°C	Up to 70°C	Up to 75°C	Up to 80°C	Up to 85°C	Up to 90°C
13 - 25	1.0 {10.2}	0.9 {9.2}	0.8 {8.2}	0.7 {7.1}	0.6 {6.1}	0.5 {5.1}	0.45 {4.6}	0.35 {3.6}	0.3 {3.1}
30 - 50	1.0 {10.2}	0.8 {8.2}	0.6 {6.1}	0.6 {6.1}	0.4 {4.1}	0.35 {3.6}	0.3 {3.1}	0.25 {2.6}	0.2 {2.0}
65 - 150	1.0 {10.2}	0.8 {8.2}	0.6 {6.1}	0.5 {5.1}	0.4 {4.1}	0.3 {3.1}	0.2 {2.0}	0.2 {2.0}	0.15 {1.5}
200	0.7 {7.1}	0.55 {5.6}	0.4 {4.1}	0.3 {3.1}	0.2 {2.0}	0.15 {1.5}	0.1 {1.0}	0.05 {0.5}	0.05 {0.5}

Notes: Maximum Working Pressure is the pressure including the water hammer pressure. Do not use them exceeding the maximum working pressure.

Short-Term Strength Test

Temperature Dependence of Tensile Strength

Relationship of Tensile Strength and Temperature between C-PVC and Other Plastics

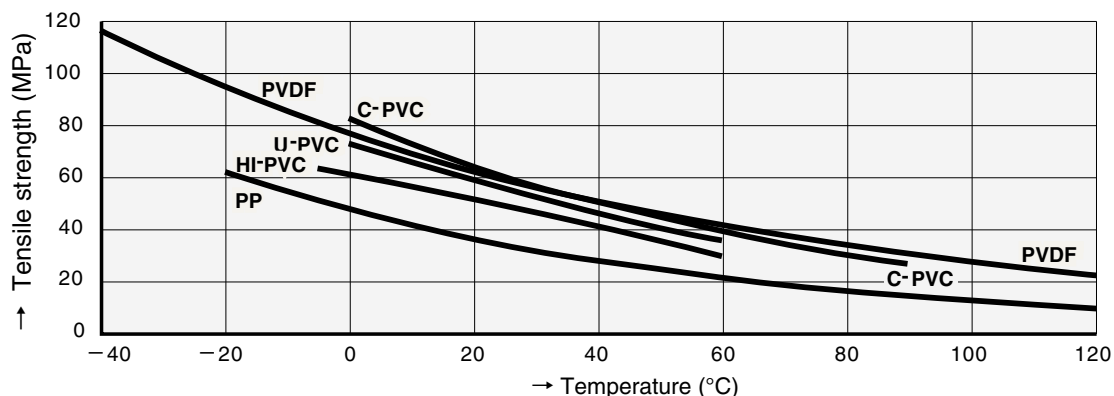

Notes: Tension speed..... 10 mm/min

C-PVC Pipe & Fittings

Elbow [L]

Size (mm)	Package: pcs.
13	100/200
16	60/120
20	35/70
25	20/40
30	40
40	25
50	15
65	14
75	10
100	5
125	5
150	3
200	2

45° Elbow [45L]

Size (mm)	Package: pcs.
20	40/80
25	25/50

45° Bend [45L]

Size (mm)	Package: pcs.
40	36
50	18
65	10
75	18
100	9
125	6
150	4

Tee [T]

Size (mm)	Package: pcs.
13	60/120
16	40/80
20	20/40
25	12/24
30	25
40	15
50	9
65	10
75	6
100	4
125	3
150	2
16x 13	50/100
20x 13	30/60
20x 16	25/50
25x 13	20/40
25x 16	15/30
25x 20	15/30
30x 13	35
30x 16	35
30x 20	35
30x 25	30
40x 13	25
40x 16	24

40x 20	22
40x 25	20
40x 30	20
50x 13	18
50x 16	18
50x 20	15
50x 25	15
50x 30	12
50x 40	12
65x 13	13
65x 16	13
65x 20	12
65x 25	12
65x 30	12
65x 40	17
65x 50	12
75x 20	9
75x 25	14
75x 30	8
75x 40	10
75x 50	10
100x 20	6
100x 25	5
100x 30	5
100x 40	5
100x 50	6
100x 75	5
125x 75	4
125x100	3
150x 75	3
150x100	2
150x125	2

Socket [S]

Size (mm)	Package: pcs.
13	120/240
16	90/180
20	50/100
25	30/60
30	60
40	35
50	20
65	30
75	16
100	8
125	4
150	4
200	4
16x 13	100/200
20x 13	70/140
20x 16	60/120
25x 13	40/80
25x 16	40/80
25x 20	35/70
30x 13	90
30x 20	70
30x 25	60
40x 20	45
40x 25	40

40x 30	40
50x 25	30
50x 30	30
50x 40	35
65x 30	25
65x 40	14
65x 50	28
75x 40	15
75x 50	20
75x 65	16
100x 40	8
100x 50	8
100x 65	8
100x 75	8
125x 75	3
125x100	3
150x 75	3
150x100	3
150x125	3

Metal-Containing Faucet Elbow [KFL]

Size (mm)	Package: pcs.
13	80
16	60
20	35
25	20
20x 13	50

Metal-Containing Faucet Socket [KFS]

Size (mm)	Package: pcs.
13	90
16	90
20	45
25	25
20x 13	45

Metal-Containing Valve Socket [KVS]

Size (mm)	Package: pcs.
13	70
16	60
20	40
25	25
30	12
40	9
50	10

Super Welding Rod

Size	Package
2 φ × S	(1kg×5) 5kg
3 φ × S	(1kg×5) 5kg
3 φ × W	(1kg×5) 5kg

Super Adhesive No.88

	Package: pcs.
250g	12/24
500g	12/24

C-PVC Pipe

Size (mm)	Package: pcs.
13	30
16	25
20	20
25	15
30	12
40	8
50	6
65	4
75	3
100	2
125	1
150	1
200	1

Installation of C-PVC Pipe/TS Connection



1 Pipe Cutting

Use wide thick paper or tape for the pipe cutting area, put a cutting gauge line with a permanent marker on the entire circumference, and cut perpendicular to the pipe shaft.



2 Chamfer

Lightly chamfer the entire inner/outer perimeters using a tool such as file or chamfer. When a pipe is cut, especially, finish the pipe end surface without burrs and warping.

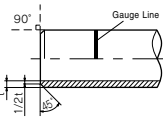

Notes: Not properly performing chamfering could cause installation failure so please make sure to chamfer.



3 Entry of Gauge Line

For the pipe insertion gauge line of the sizes 13 to 40 mm, measure the fitting socket length ℓ from the pipe end and mark on the pipe body with a marker. For the pipe insertion gauge line for the sizes 50 to 150 mm, it shall be at a position of the zero point plus the bonding margin length in Table 2. Mark the gauge line on the pipe body with a permanent marker.

Table 1. TS Fitting Socket Normal Length Unit: mm

Size	13	16	20	25	30	40	50	65	75	100	125	150
Fitting Socket Length	22	27	33	38	42	47	52	61	64	84	104	132

[Reference] Table 2. Bonding Margin Length Unit: mm

Size	13	16	20	25	30	40	50	65	75	100	125	150
Bonding Margin Length	7	9	11	13	14	16	17	20	25	30	35	45

* Refer to [Explanation] 2.



4 Rinsing

Wipe and clean the inner face of fitting socket and the outer face of pipe insertion port with a cloth. In particular, when oil or water is on the connection part, clean by using a small amount of acetone and alcohol.

Notes: Not properly performing rinsing could cause installation failure so please make sure to rinse.



5 Adhesive Application

Use a special adhesive (No.88) compatible to the type of pipe and apply it evenly in the order of on the inner face of fitting and the outer face of pipe. In particular, apply thinly and evenly to the inner face of fitting. The reference ratio of adhesive application is 7 to 3 for pipe and fitting.

Table 3. Usage of Adhesive per Connection Part (Reference)

Size (mm)	13	16 (15)	20	25	30 (32)	40	50	65	75	100	125	150
Usage (g)	0.9	1.2	1.7	2.0	3.1	5.0	7.1	9.9	12	20	30	44

* Refer to [Explanation] 4.



6 Insertion

After applying adhesive, insert pipe into fitting straight without turning the pipe immediately at once and press it in that condition. Refer to Table 4 for this normal press time.

Table 4. Normal Press Time of TS Connection

Size (mm)	50 or less	65 or more
Normal Press Time (Sec.)	30 or more	60 or more

* Use an inserter for large diameters.

Notes: Due to the relationship of pipe and fitting dimension tolerance, it may not be inserted all the way to the end. In this case, do not insert it forcibly by hammering and such. Inserting forcibly may place a large burden on the fitting and cause damage.



7 Adhesive Treatment

After connection, wipe the protruded adhesive immediately and do not apply forcible stress on the connection part.



8 Removal of Solvent Content

Adhesive contains organic solvent, and the solvent steam needs to be removed after connection. During curing after piping, open both ends of pipe without enclosing and remove the solvent steam. During curing, the steam can be removed more effectively by ventilating inside piping using a ventilator (low-pressure specification) or washing inside piping by filling the water after the adhesive is hardened.

* Refer to [Explanation] 4.

[Explanation]

1 TS connection utilizes the swelling and elasticity of PVC by making the fitting socket tapered and using adhesive. Applying adhesive to the pipe and fitting would create a swelling layer of approximately 0.1 mm thickness on its surface as shown (Figure 1), and this layer makes the insertion of the pipe fluidly. After insertion, respective swelling layers of the pipe and fitting would interact each other, and the bonding surface would be unified.

Figure 1. Installation of TS Connection

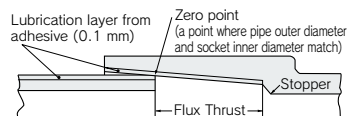
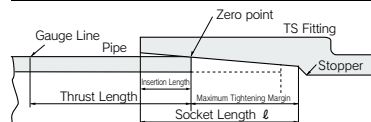

Figure 2. Zero Point and Tightening Margin



2 Based on a result of testing the relationship between the bonding margin length and pressure-resistant strength, it has been confirmed that practically acceptable water pressure strength can be secured by inserting approximately 1/3 of the fitting socket [ℓ] in addition to the insertion length without applying adhesive (zero point).

In regards to insertion margin in TS connection, it is ideal to insert TS fitting to the length of TS fitting gasket (stopper), but considering the tolerance of pipe and fitting dimensions, the length from zero point plus the bonding margin length shown in Table 2 to the stopper in Table 1 is sufficient enough, and inserting to the stopper of the fitting is not necessarily required.

However, if it cannot be inserted due to the adhesive being dried, etc., cut the connection part and reconnect again by using a new socket.

3 Inserting the pipe into the fitting before applying adhesive is to check the zero point. In this case, a combination of pipe and fitting that provide the insertion length of 1/3 to 2/3 ℓ from the pipe end surface (refer to Figure 2) is standard.

4 Be cautious of excessive adhesive (it may cause solvent cracking and damage). Caution is needed in low-temperature installation because solvent steam does not evaporate easily and tends to remain (it may cause solvent cracking and damage). During curing after piping, open both ends of pipe without enclosing and remove the solvent steam. During curing, the steam can be removed more effectively by ventilating inside piping using a ventilator (low-pressure specification) or washing inside piping by filling the water fully after the adhesive is hardened.

C-PVC Pipe Precautions

Design

Caution Working Pressure vs. Temperature

Working pressure differs by temperature and size. Use within an allowable range of relationship between maximum working pressure and temperature.

Caution Use for Hot Water Equipment

Avoid using them for instant heater. If the instant heater breaks down or has a malfunction, water or steam of abnormal temperature may flow and damage piping.

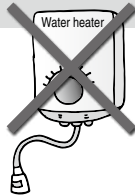

Caution Expansion/Contraction Treatment

Since AV C-PVC pipes have a higher heat expansion/contraction amount compared to steel pipes, an expansion/contraction treatment is important. Not performing an expansion/contraction treatment could cause damage. Provide a treatment to absorb expansion/contraction using AV expansion joints or elbows, etc.

Fitting Type	Size	Expansion/Contraction Absorbable Amount	Implementation example (absorbable expansion/contraction length)
AV Expansion Joint	20 mm to 100 mm	(Size 20 to 75 mm) 80 mm (Size 80 to 100 mm) 100 mm	Use to absorb expansion/contraction at a straight part. • When length of the straight part is over 4 m * In the case of temperature difference of 70°C or less.
Elbow	13 mm to 200 mm	—	Use to absorb expansion/contraction at a bending part. • When length of the straight part is 2 m or less • When length of the straight part is 2 up to 4 m

Caution Piping Under Concrete

Avoid using AV C-PVC pipes for burring under concrete or mortar.

Caution Multi-Branching Piping

Avoid using AV C-PVC pipes for multi-branching piping in bath, etc. and consider using lining steel pipes, etc.

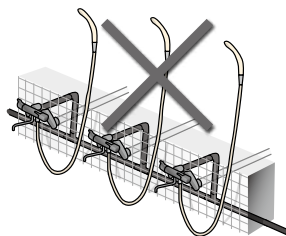

Caution Piping Support/Fixation

U-bands (with rubber seat) are recommended for fixing piping.

In the case of using U-bolts inevitably, provide a cushion such as rubber to prevent the pipes from touching the hardware directly. Cushion saddles and U-bolt rails are available as a cushion material. Please consider using them. Be cautious not to tighten nuts excessively. As a reference of nut tightening, ① tighten by hand and then rotate 1/2 using a spanner, etc., or ② tighten by setting torque wrench at 1N · m (10kgf · cm).

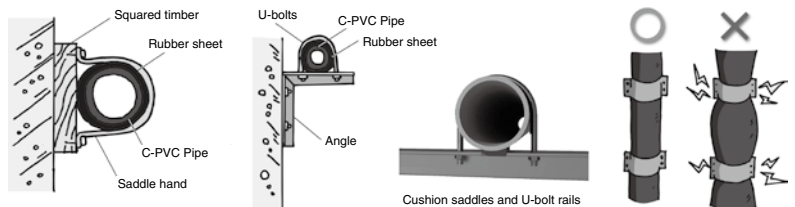

Caution Use for Industrial Kitchen Drainage Piping

Do not use them for piping draining from the steam convection oven, one of kitchen equipment. Detergents used in steam convection oven may contain ingredients that would give a negative influence (cracking, water leakage, etc.) to pipes and fittings.

Caution Piping to Architectural Structure

When using as piping for high-rise architectural structure such as buildings, consider not only the pump pressure but also the influence of the water head pressure (height) and use within a range of allowable relationship between maximum working temperature and pressure. If securing space for sufficient expansion/contraction measure is difficult, do not use AV C-PVC pipes and consider using other types of pipes (copper pipes, lining steel pipes, metal reinforced double laminated pipes, cross-linked polyethylene pipes, etc.)



* Vertical piping, buried piping, etc. are examples of places where implementing an expansion/contraction measure is difficult.

Caution Expansion/Contraction Absorption at Branch Area

For branching out from the main pipe side, the stress generated by expansion/contraction of the main pipe shall not be focused on the fitting of a branch point. For the purpose of branching method, basic items requiring an extra attention are as follows.

- Never execute direct branching and avoid having expansion/contraction of the main pipe give an impact to the branch pipe side by placing an elbow.
- Locate a branch point of the main pipe near a fix point as much as possible.

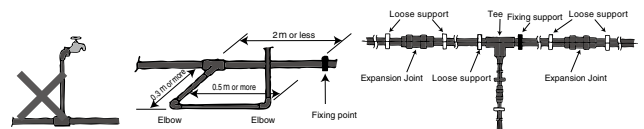

* Also refer to [Piping Support/Fixation].

Caution Use of Rubber Ring Joint

Fittings that use a rubber ring to tighten pipes cannot be used.



Warning Use for Chemical Solution Piping

In the case of using for chemical solution piping, please consult our nearest office whether or not it is usable in advance.



Precautions

⚠ Caution

If handled inappropriately, "it may cause death or serious injuries."

⚠ Warning

If handled inappropriately, "it may cause injuries or physical damage."

Installation

⚠ Caution Handling

Do not drop or throw during transportation and piping.

⚠ Warning Use of Adhesive

AV Cement is applicable to the "second class organic solvents, etc." in the Ordinance on Prevention of Organic Solvent Poisoning.

If indoor usage per hour exceeds the following allowable usage, "Ordinance on Prevention of Organic Solvent Poisoning" will be applied and qualification of "operation chief of organic solvents" will be required.

For details, please check with the local Labour Standard Inspection Office.

Allowable adhesive usage W (g/time) = 0.4 (g/m³ · time) × workplace cubic capacity (m³) Cubic capacity of room excludes a space at 4 m or higher from the floor surface. However, if the cubic capacity exceeds 150 m³, it shall be 150 m³. To prevent poisoning from organic solvents or fires, be cautious of ventilation and avoid flammables.

⚠ Warning Contact with Organic Compounds

Do not spray or apply an organic compound to cause a negative impact to the material of pipes and fittings such as acetone, thinner, creosote, pesticide and termite extermination agent. Even if the compounds above do not touch the pipes and fittings directly, they might damage the pipes and fittings buried shallow through penetration into the soil when if spilled on the ground.



* Exclude acetone and alcohol to be used for cleaning of pipes and fittings before connection.

⚠ Caution Use of Sealing Agent (Threaded End Connection Part)

Make sure to use seal tape for thread connection part. Using liquid seal or liquid gasket could cause stress cracking due to the organic solvent contained and lead to damage of fittings or water leakage.

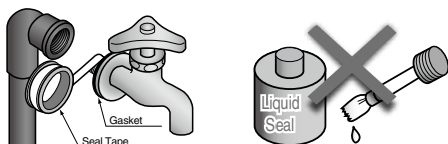

⚠ Warning Completion Inspection

Make sure to perform a completion inspection under water pressure after curing for a sufficient amount of time following the bonding work.

Do not perform an airtightness test by using air (compressed air or positive-pressure gas) as it is extremely dangerous.



⚠ Warning Selection of Adhesive

Make sure to use AV Adhesive No.88 (For Heat-Resistant Unplasticized Polyvinyl Chloride Pipe).

Try to apply adhesive thinly and evenly. Applying too much could cause solvent cracking, etc. and lead to water leakage.



⚠ Warning Storage of Adhesive

AV cement is applicable to "Class 1 Petroleums, Class 4 Hazardous Materials" of Article 2 of the Fire Services Act. Follow the laws and regulations and municipal ordinances for storage. Avoid flammables after use and store in a cool and dark place.

⚠ Caution Connection

Insert straight immediately after applying adhesive and hold it sufficiently to prevent "returning." When inserting, do not insert it forcibly by hammering and such.

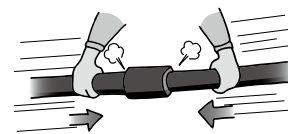

⚠ Warning Wear mask and gloves

Avoid contacting to the skin during handling, and wear organic gas mask or air-supplied respirator, protection gloves, protection glasses and others, as necessary. If contacted to the skin, rinse with soap and water immediately.



⚠ Warning Use of Sealing Agent (Wall/Floor Penetration Part)

A sealing agent is sometimes used to fill a gap when penetrating piping through wall and floor. Please check with the manufacturer of sealing agent in advance as some sealing agents contain plasticizer (phthalate ester, DOP, etc.) or organic solvent that could cause a negative influence and damage or cause water leakage from unplasticized polyvinyl chloride pipes and fittings.

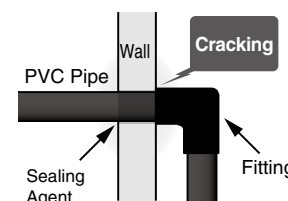

Piping Design Precautions

- Select an appropriate material in consideration of use conditions (fluid type, temperature, pressure, etc.) For details, please consult our nearest office in advance.
- Maximum working pressure is the pressure including the water hammer pressure. Do not use them exceeding the maximum working pressure.
- As maximum working pressure differs by size and temperature, design and use within the allowable range.
- Since they are made from plastic, heat expansion/contraction against temperature change is large compared to metals and heat stress is also generated. Therefore, perform piping support or expansion/construction treatment applicable to the use conditions and installation place.
- In the case of using under the positive-pressure gas, a dangerous condition is expected due to the particular reaction force of compressive fluid even when the value is the same as the water pressure. Therefore, implement a safety measure such as covering pipes with a protection material, etc. to protect the surrounding area before use.
- Do not joint with solvent adhesive or welding connection on differential plastic materials (It may cause damage)

Transportation Precautions

- Do not drag them as it could scratch pipes. Do not drag them as both ends of pipes are easily damaged.

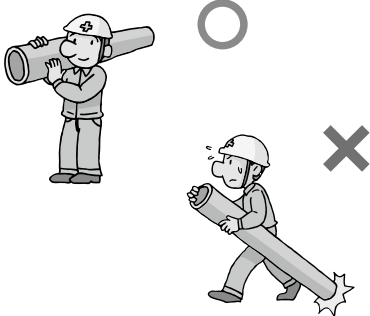

- Two people should handle a pipe with the size of 150 mm or more.

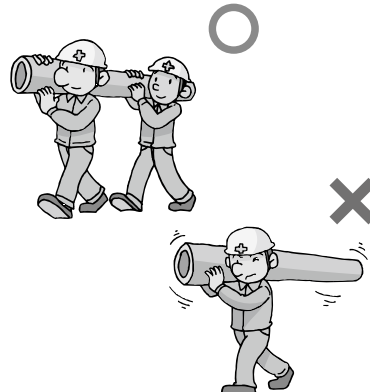

- Do not throw pipes from the truck platform.

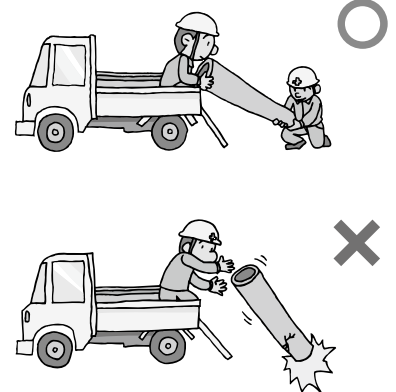

Storage Precautions

- When storing pipes and fittings outside, avoid direct sunlight and implement a measure such as placing a sheet in a way of avoiding heat accumulation.

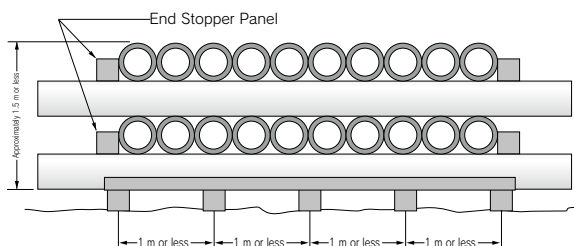

- Do not leave fittings in an enclosed condition (inside a vehicle in Summer, in an enclosed plastic bag, etc.) under a high temperature atmosphere.

Enclosed vehicle
(may deform due to heat)

Packed products in
an sealed condition

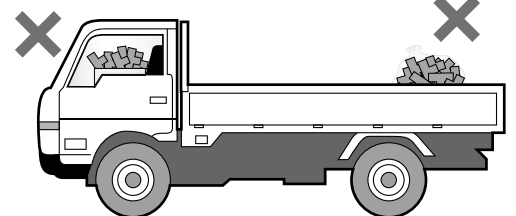

Installation

- Follow our installation procedure to fully exert the work safety and piping performance for installation.
- Make sure to use the specified AV cement for bonding AV PVC pipes.
- Be cautious of excessive adhesive (it may cause solvent cracking and damage). Caution is needed in low-temperature installation because solvent steam does not evaporate easily and tends to remain (it may cause solvent cracking and damage). During curing after piping, open both ends of pipe without enclosing and remove the solvent steam. During curing, it can be removed more effectively by ventilating inside piping using a ventilator (low-pressure specification) or washing inside piping by filling the water fully after the adhesive is hardened.
- Make sure to perform a completion inspection under water pressure. Do not perform an airtightness test by using air (compressed air or positive-pressure gas) as it is extremely dangerous.

Solvent Cracking (SC) Measure

SC (Solvent Cracking) is a type of stress cracking and specifically distinguished from the cracking phenomenon that occurs when solvent gives an impact inside PVC pipe. SC is caused by the existence of solvent (adhesive, preservative, etc.) It tends to occur more easily due to stress (heat stress, stress of TS connection part, bending, other external stress) and installation during low-temperature like in Winter (solvent tends to remain). When piping, implement a SC measure as explained as follows.

Item	Measure
Adhesive Usage	Apply adhesive compatible to the type of pipe thinly and evenly. Do not apply adhesive extending out from the insertion length on the pipe outer face. In particular, apply thinly and evenly to the inner face of fitting. The reference ratio of adhesive application is 7 to 3 for pipe and fitting.
Wiping of Adhesive	After bonding, make sure to wipe off the protruded adhesive with a cloth after inserting. During application, remove the adhesive spilled on the groove floor.
Opening of pipe on both ends	Fully open valve, air valve, blind flange, etc. for better ventilation and remove the solvent stream (do not enclose).
Utilization of Prefab Method	Prefabricate 2 to 4 pipes in advance, remove the solvent steam by natural ventilation and then connect the pipes.
Ventilation inside Piping	During curing after piping, open both ends of pipe without enclosing and remove the solvent steam (do not enclose). During curing, the steam can be removed more effectively by ventilating inside piping using a ventilator (low-pressure specification).
Washing inside Piping	During curing after piping, open both ends of pipe without enclosing and remove the solvent steam. It is more effective if you fill water all the way and wash after the adhesive is hardened (do not apply the water pressure at this time). Immediately perform this after leaving 30 minutes for the size of 50 mm or less and approximately 1 hour for the size of 65 mm or more.
Expansion Measure	Implement an expansion/contraction treatment to prevent the heat stress from rising due to temperature differences.
Support	When fixing piping, try to avoid using U-bolts as much as possible and use fixation bands with a wider width. In the case of using U-bolts, provide a cushion such as rubber to prevent piping from touching U-bolts. Be fully cautious not to tighten the fixation bands and U-bolts too much.

Adhesive Usage

Do not apply adhesive extending out from the gauge line.

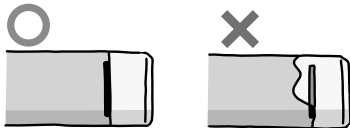

Apply thinly and evenly to the inner face of TS fitting gasket.

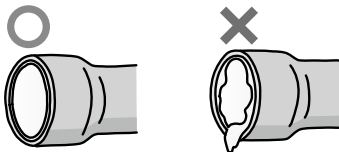

Wiping of Adhesive

Wipe off the protruded adhesive with a cloth after inserting.

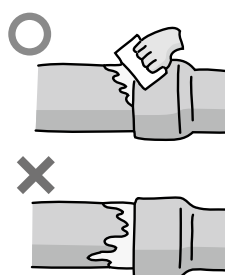

Support

Be cautious not to tighten saddle bands, U-bolts and U-bands too much.

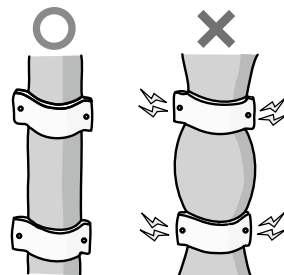

Expansion Measure

Provide expansion/contraction treatment to lower the heat stress.

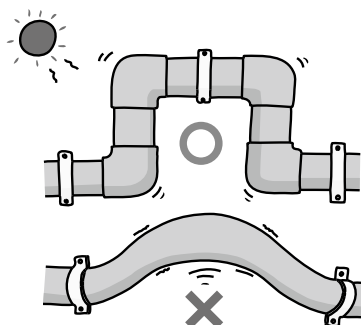

Removal of Solvent and Opening of Pipe on Both Ends

Ventilation

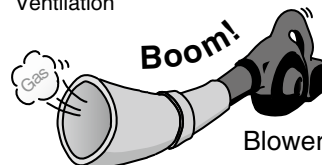

Washing with water



Opening of pipe on both ends

